

# Ứng dụng của microfluidic trong nghiên cứu tế bào gốc

Dương Duy Dương | Ph.D

# Tế bào gốc là gì?

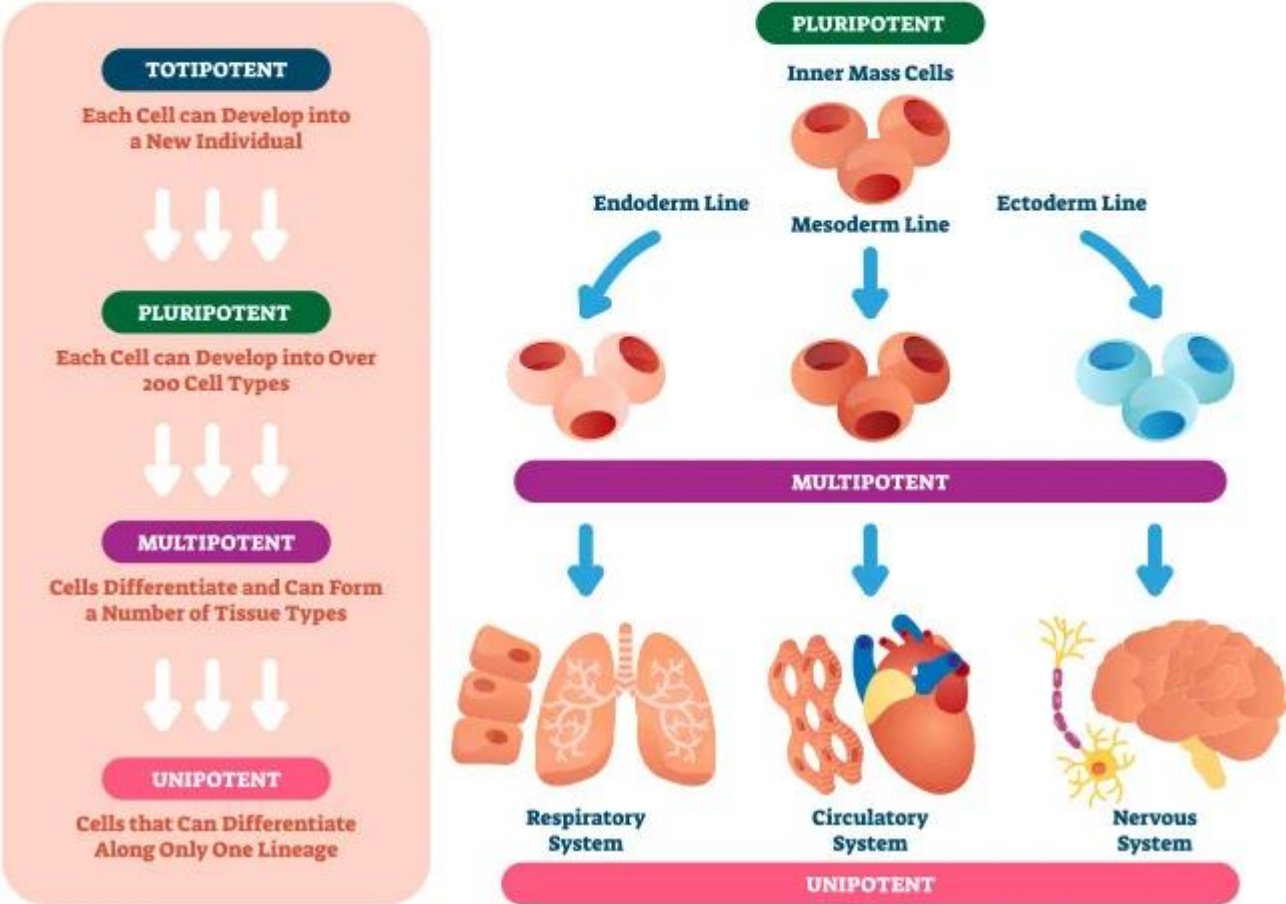
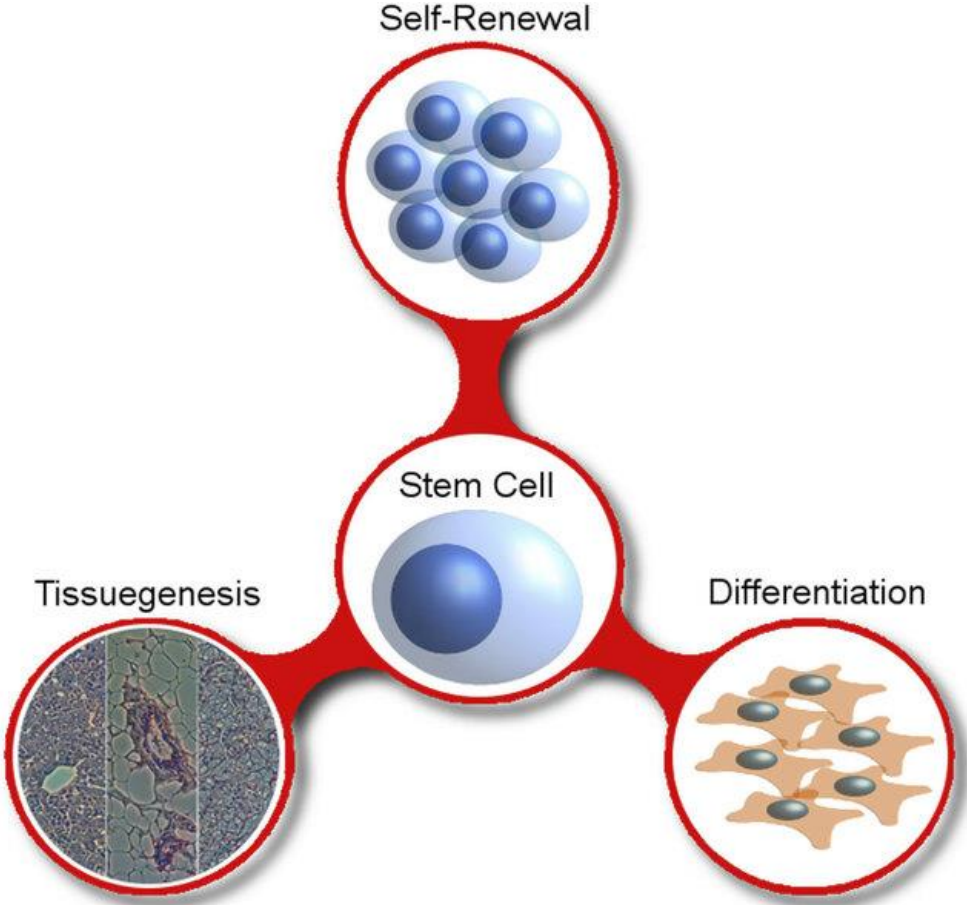
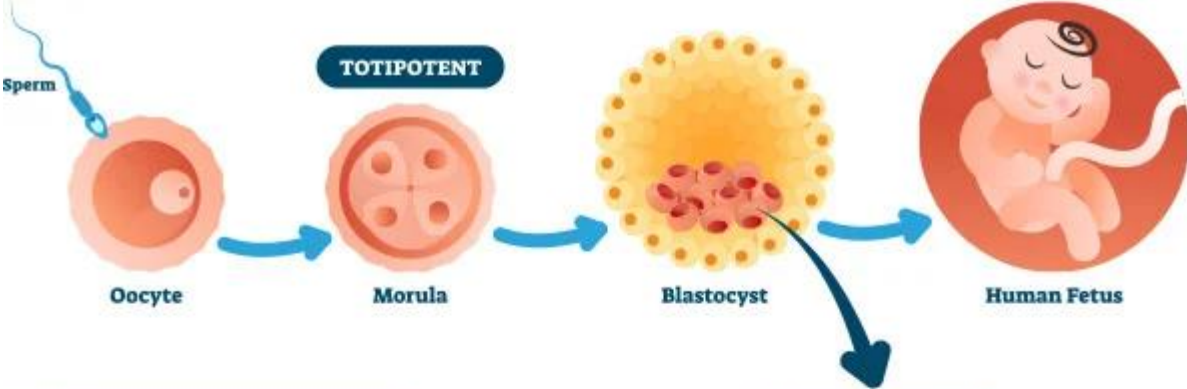

<https://beikecelltherapy.com/stem-cell-banking-what-you-need-to-know/>

<https://www.stem-cell-hawaii.com/about/what-are-stem-cells/>

# Microfluidic là gì?

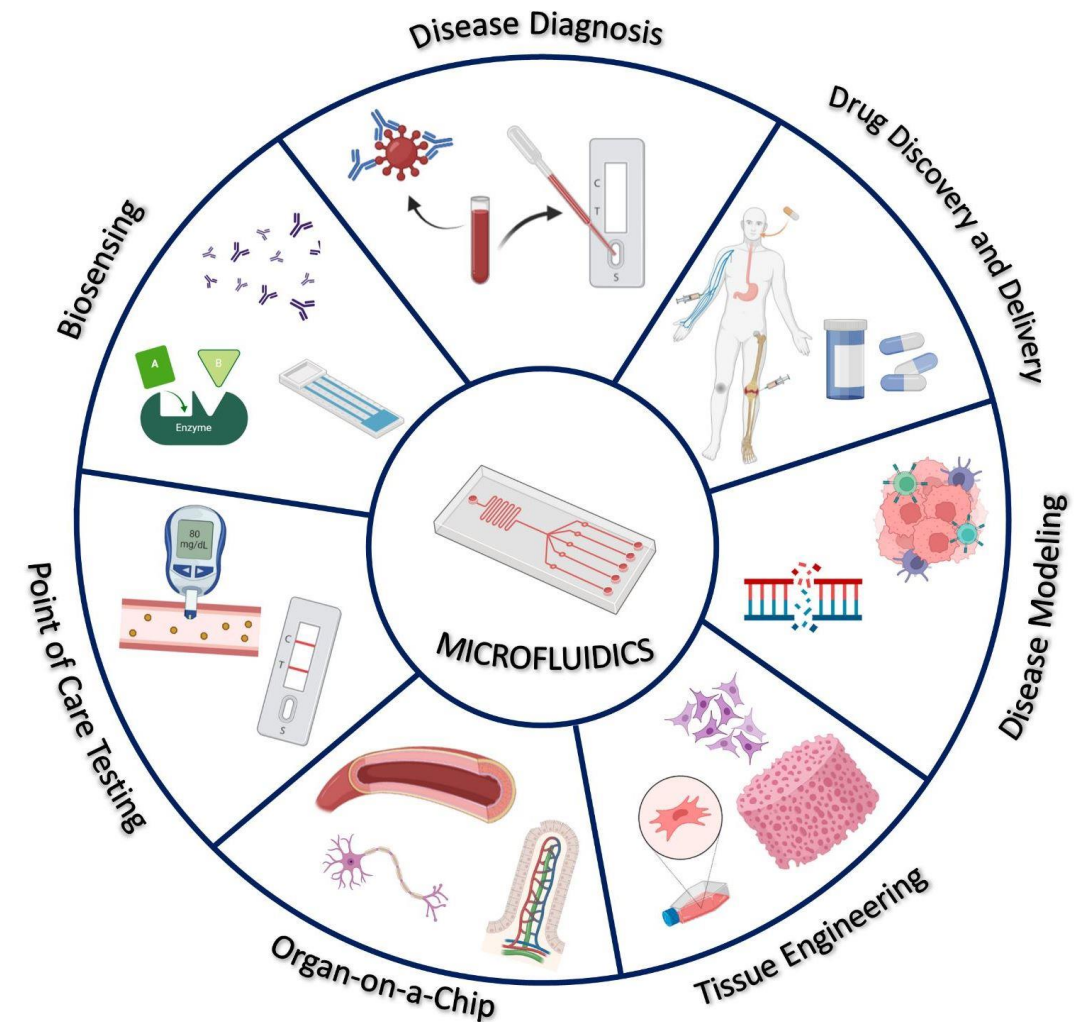
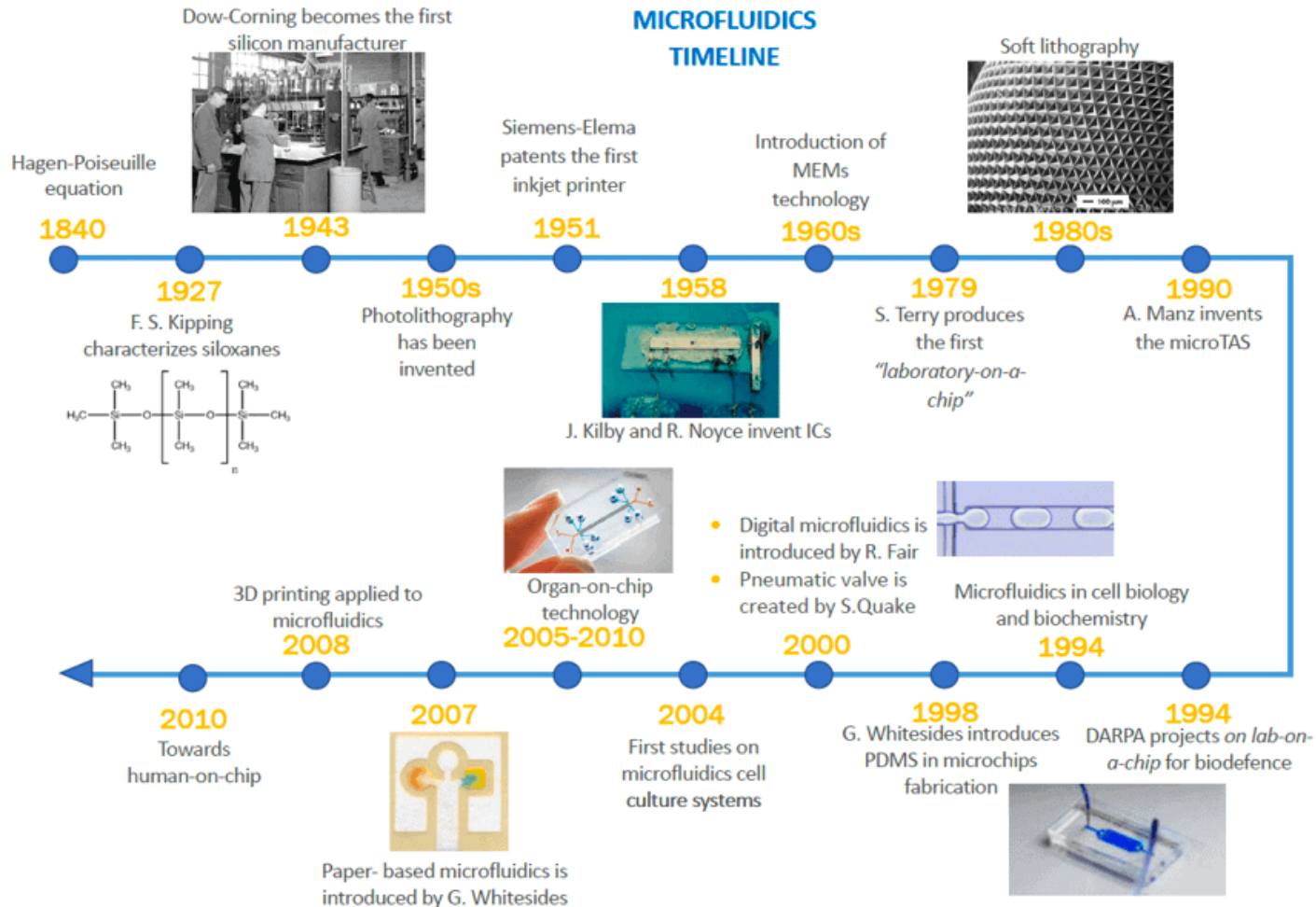

# Dòng công việc trong nghiên cứu tế bào gốc

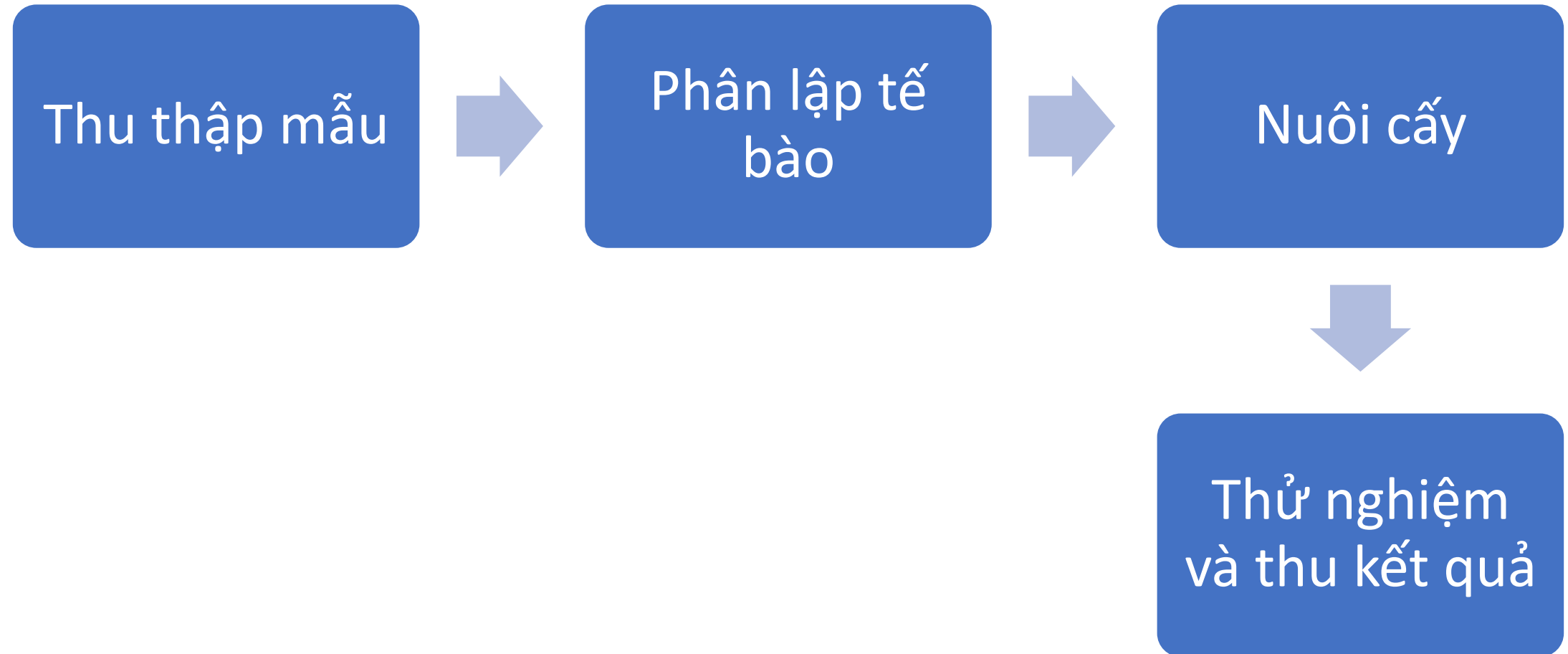

**Thu mẫu**

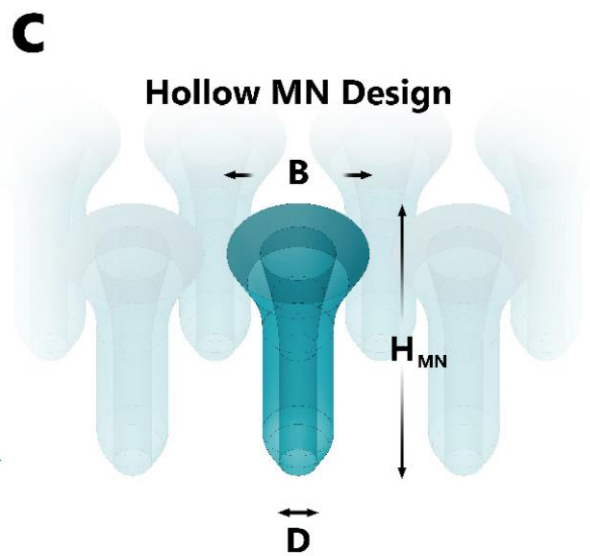
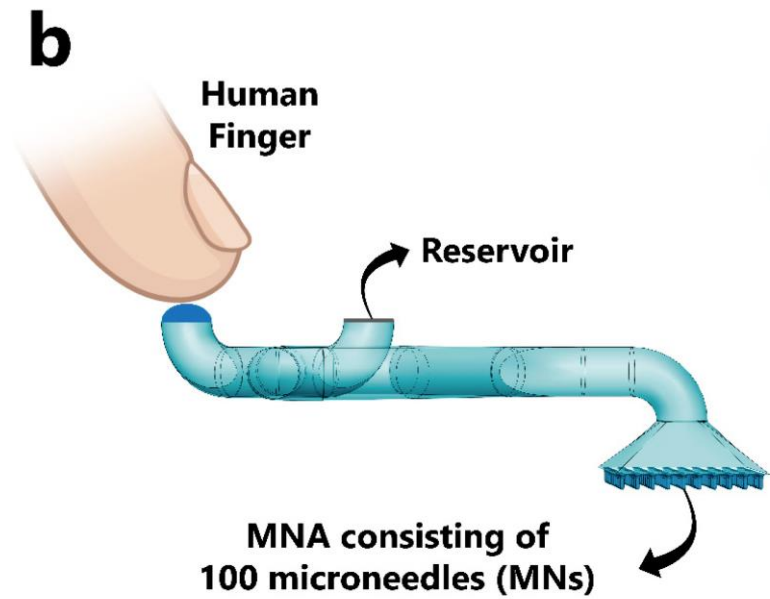
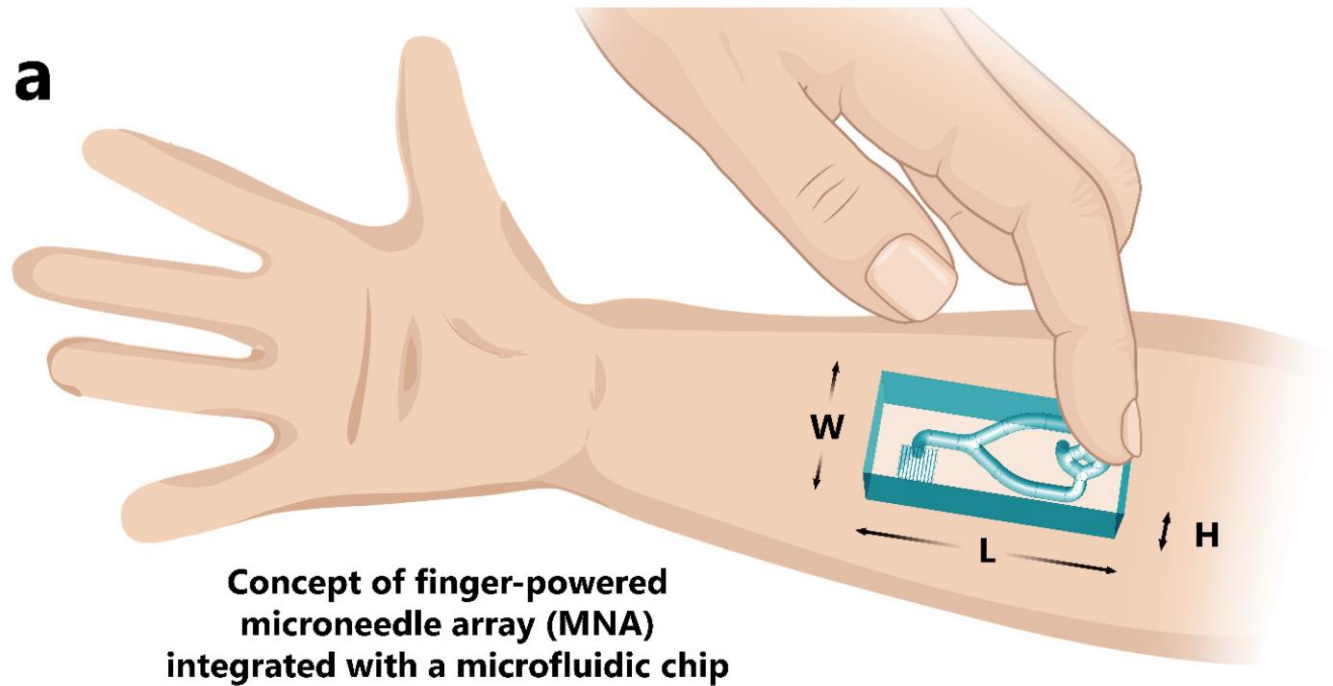

# Phân lập tế bào

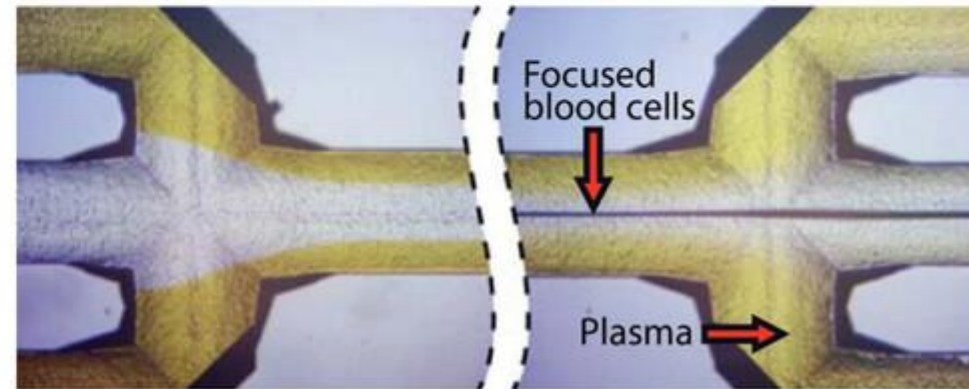
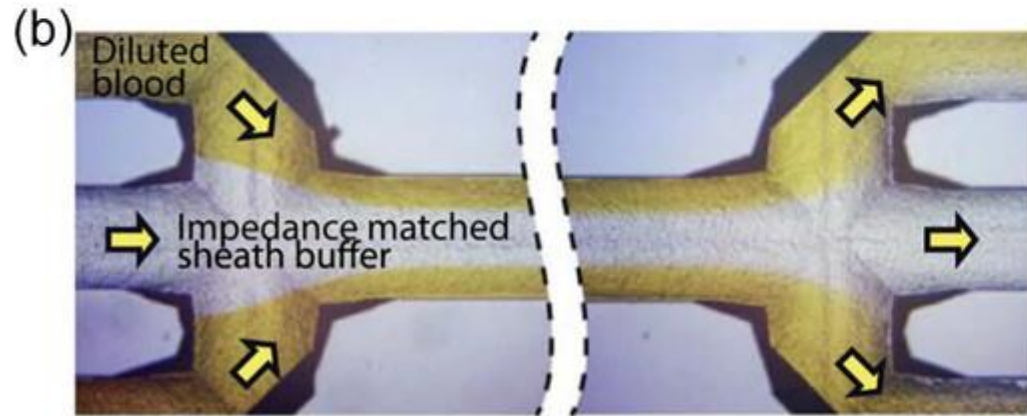
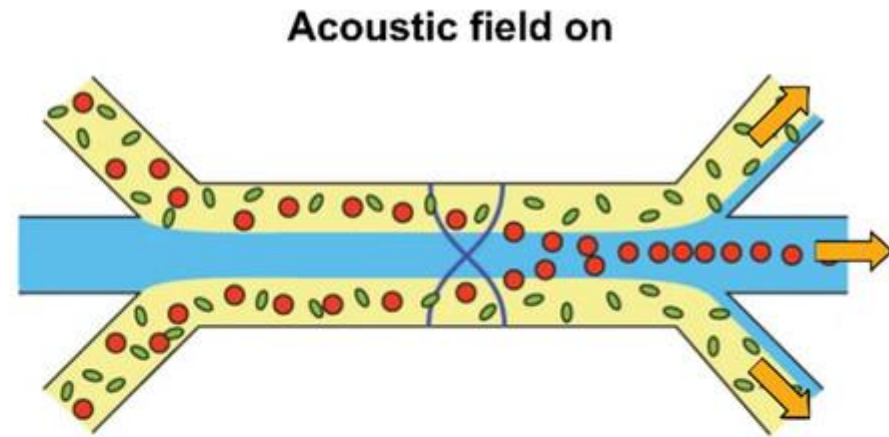
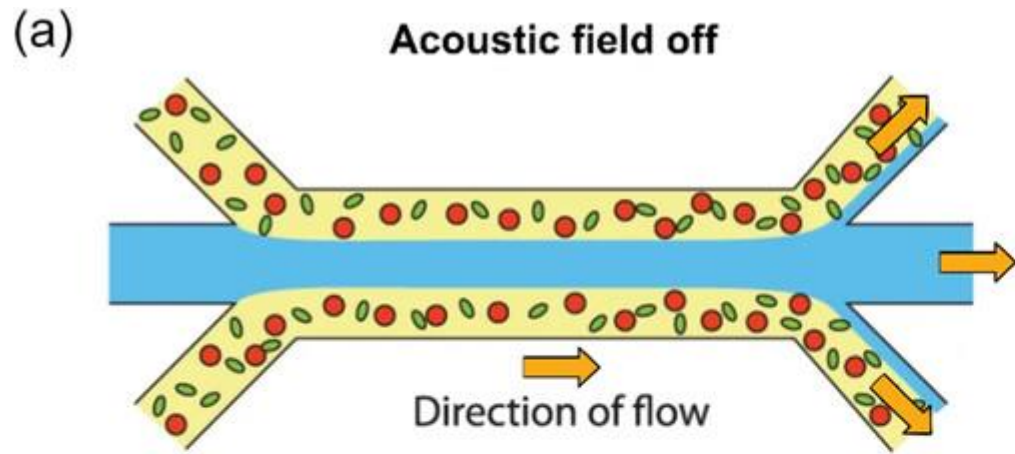



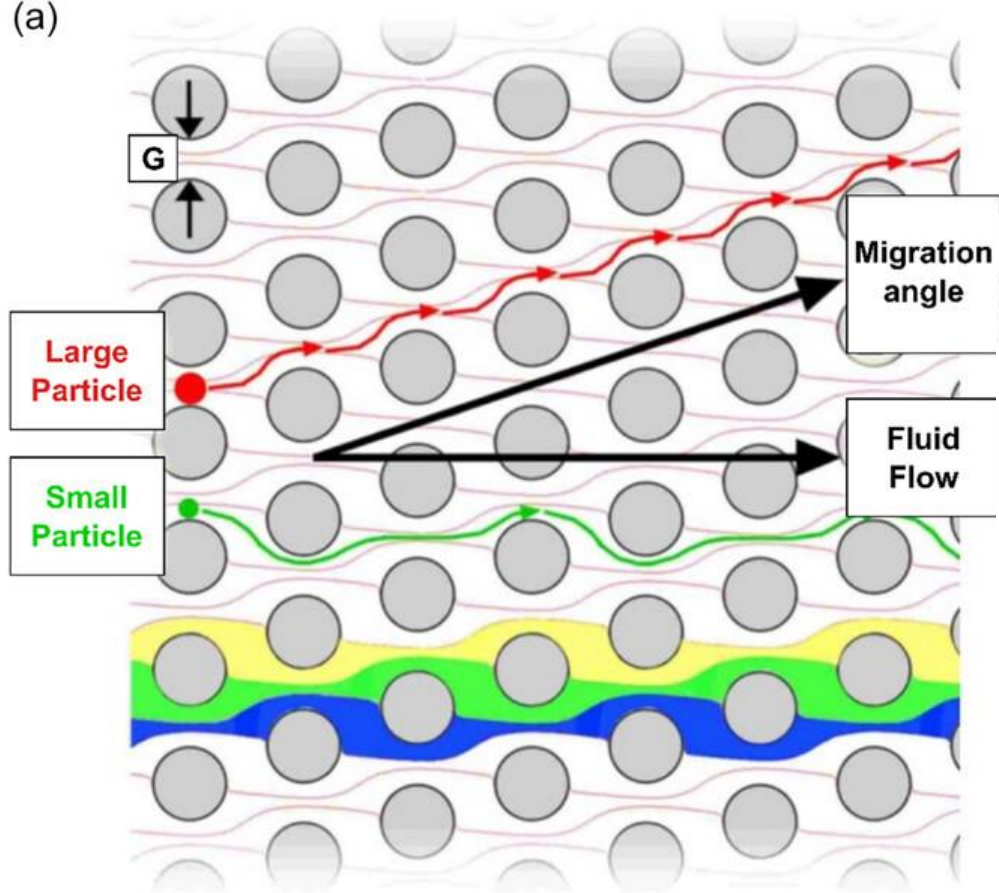

(b) Entrance of the array

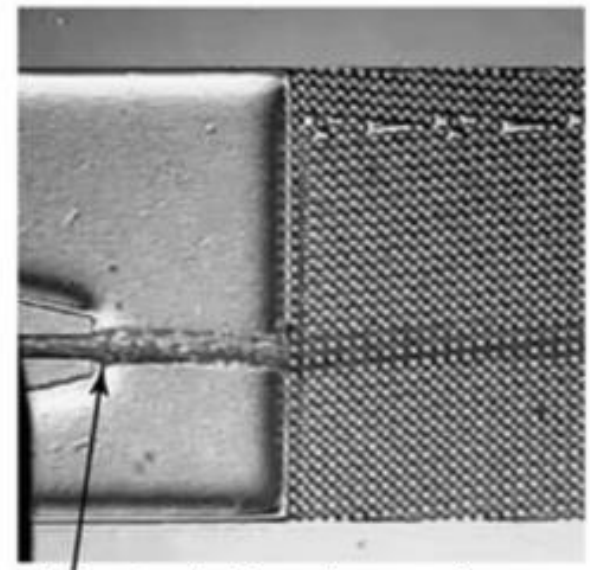

Exit of the array  
Large cell

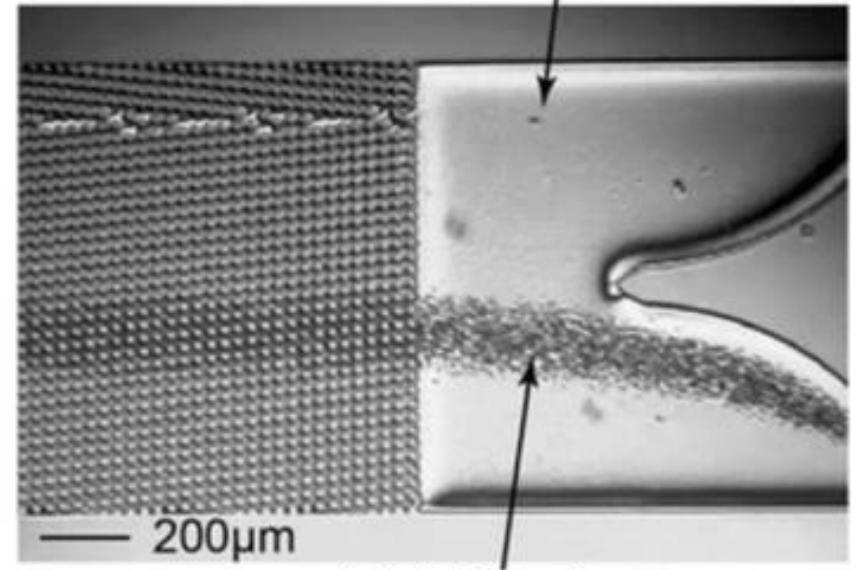

(b) Entrance of the array

Exit of the array  
Large cell

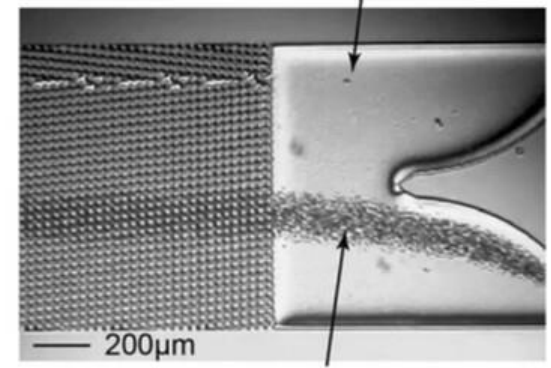
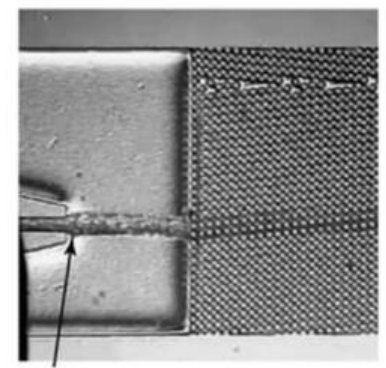

# Nuôi cấy

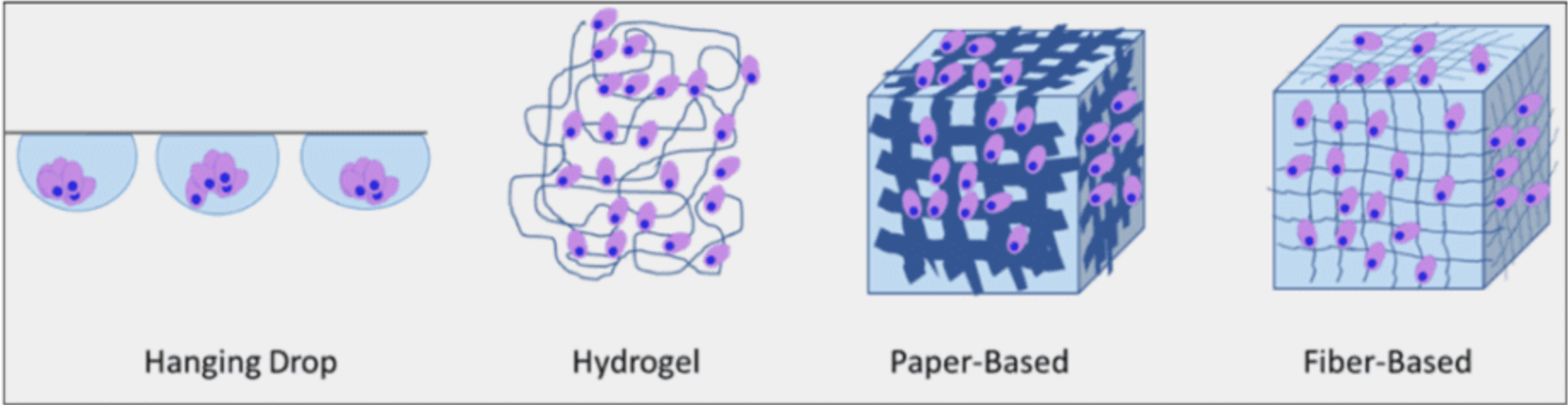

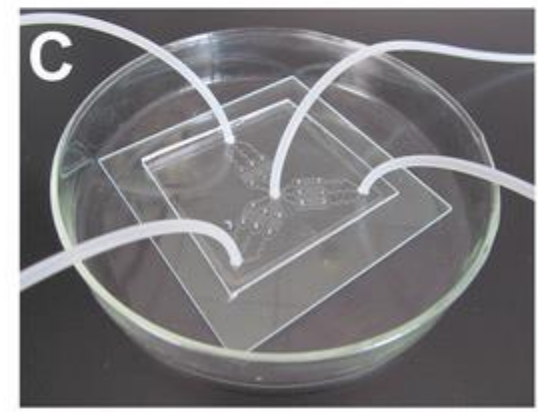
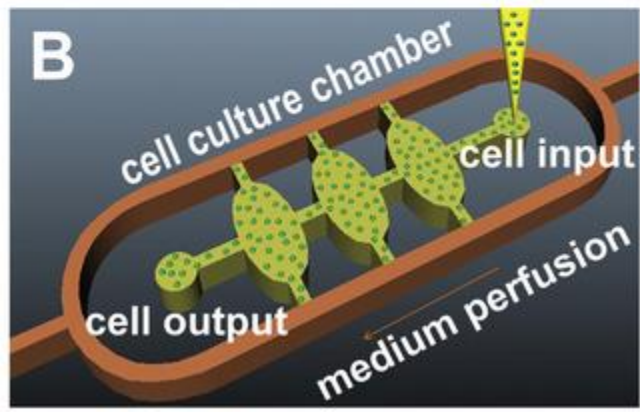
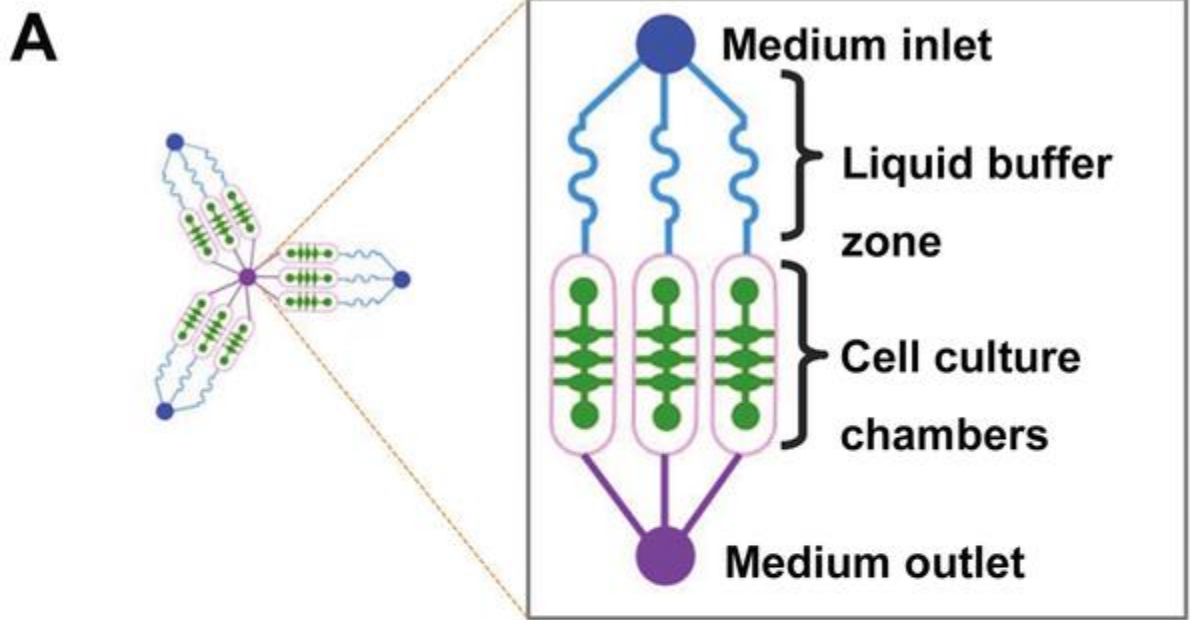
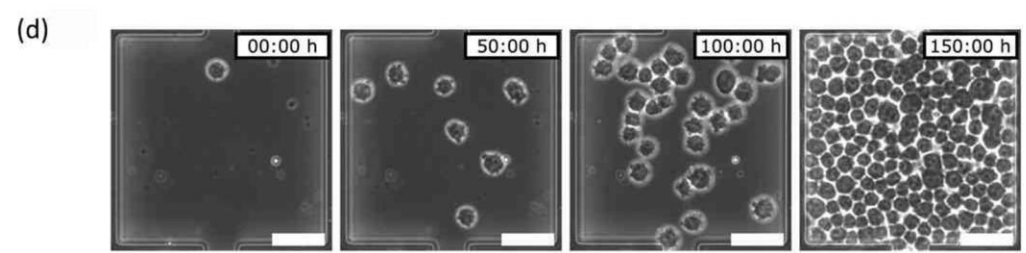
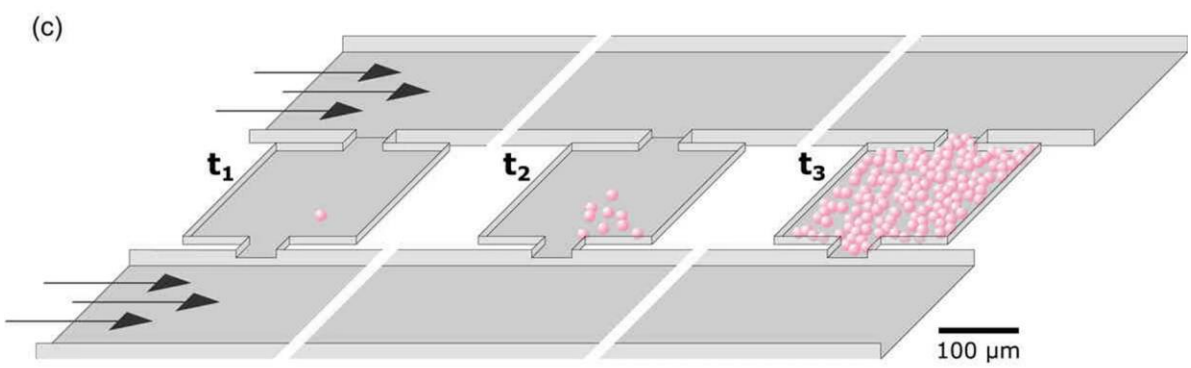
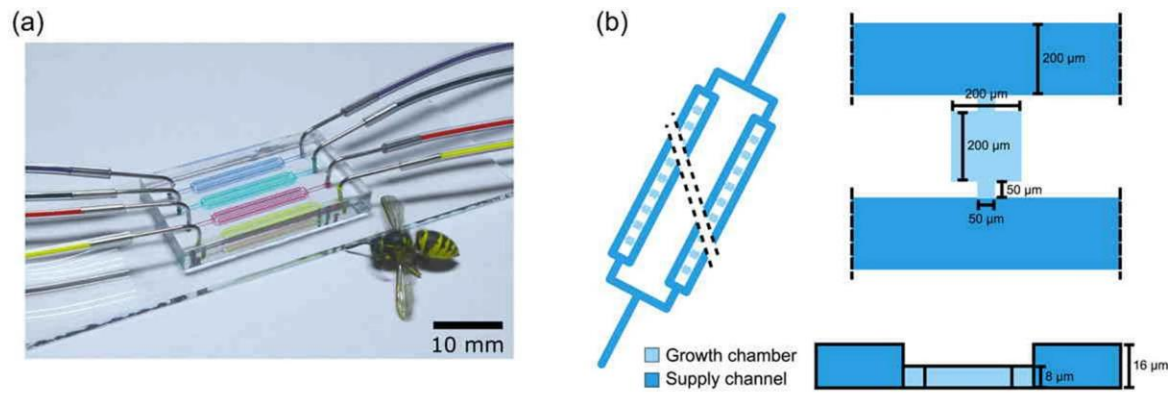

### Spheroids-on-chip

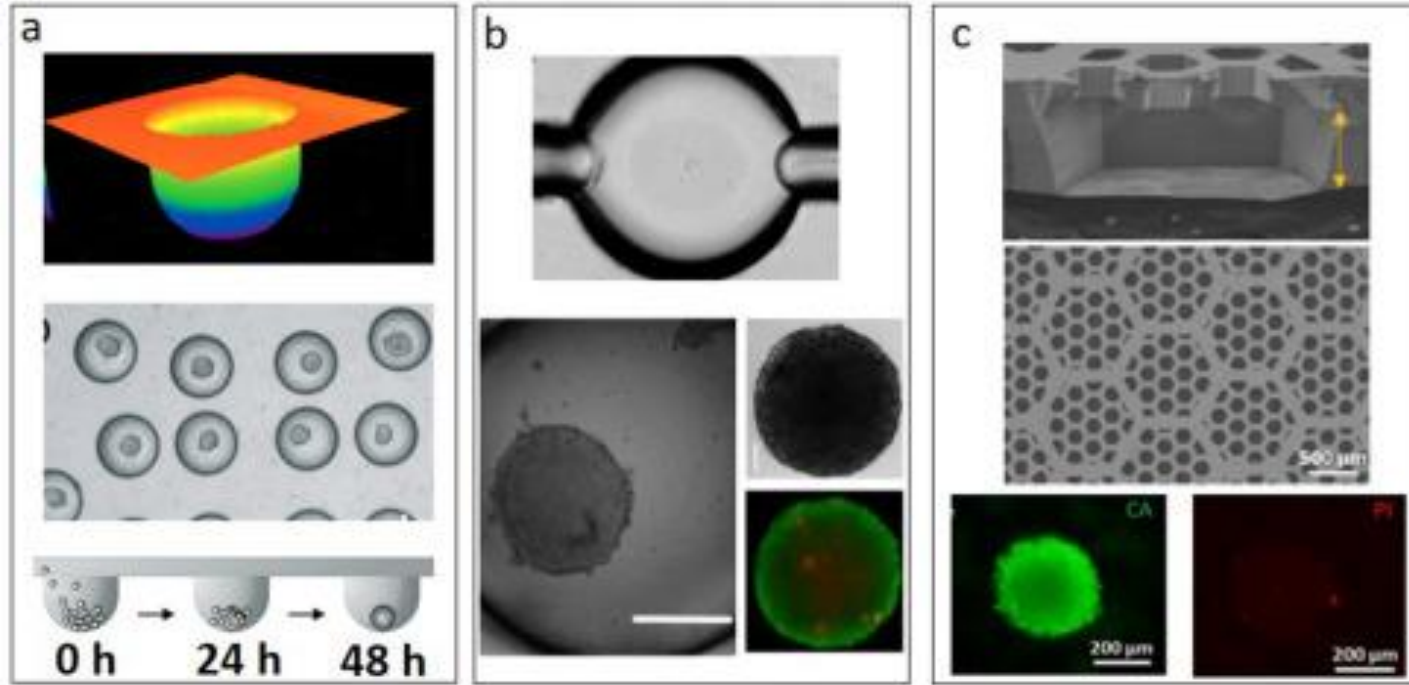

### TME-on-chip

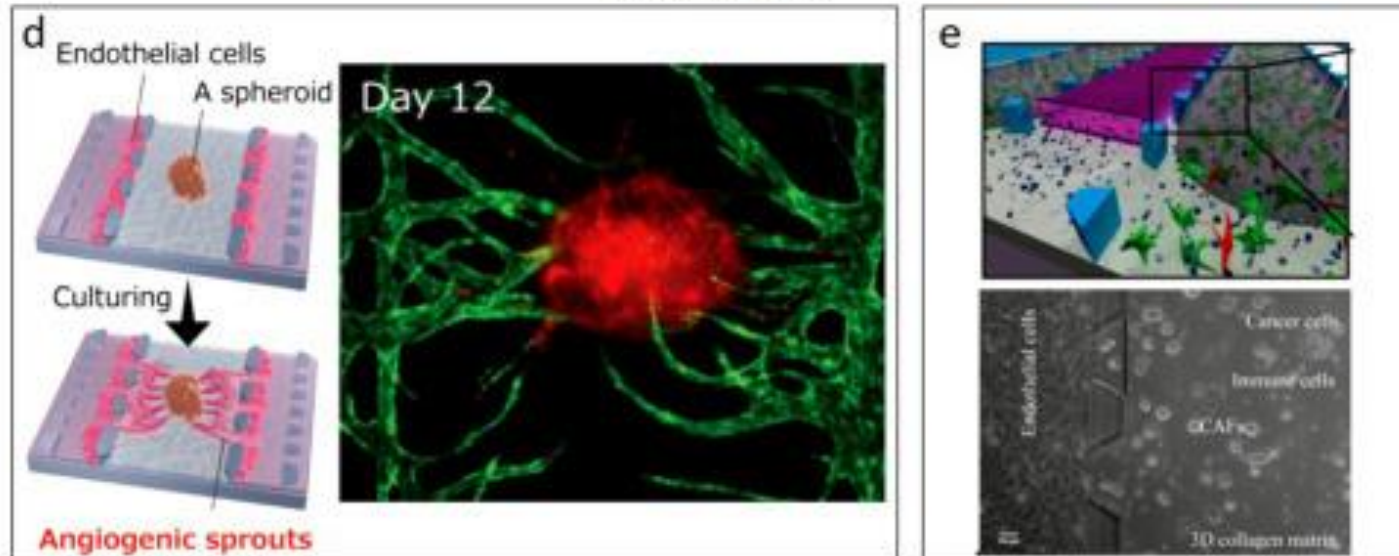

# Thử Nghiệm và thu kết quả

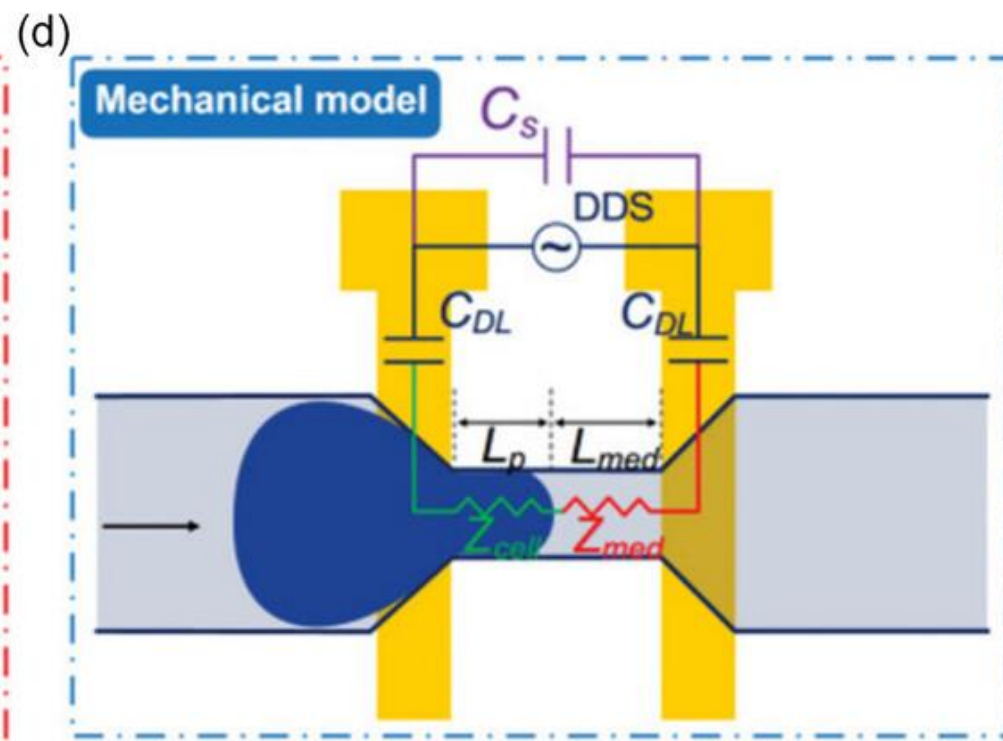
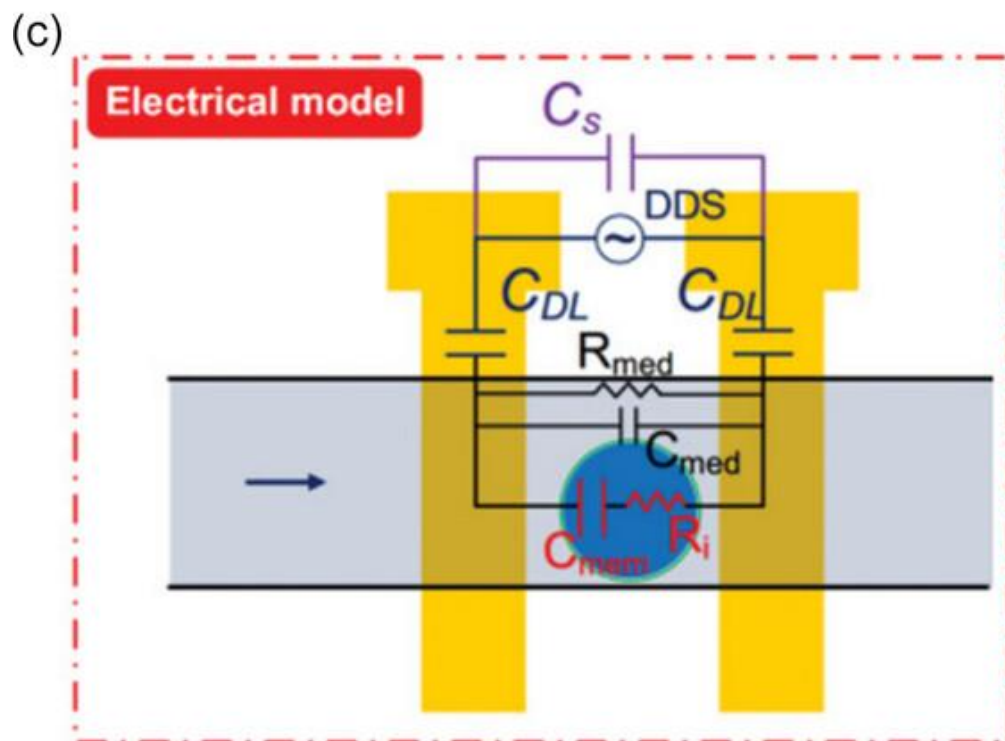
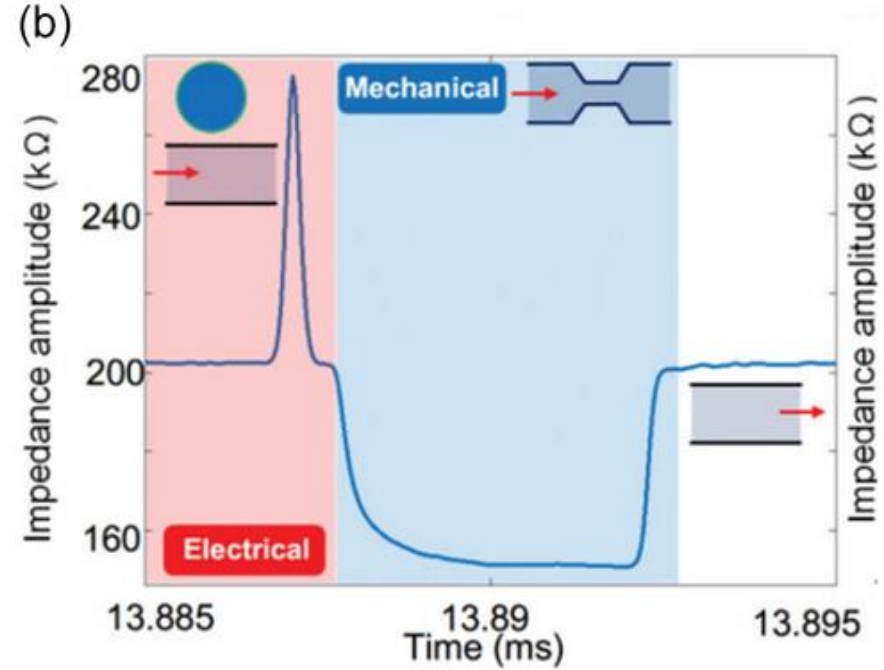
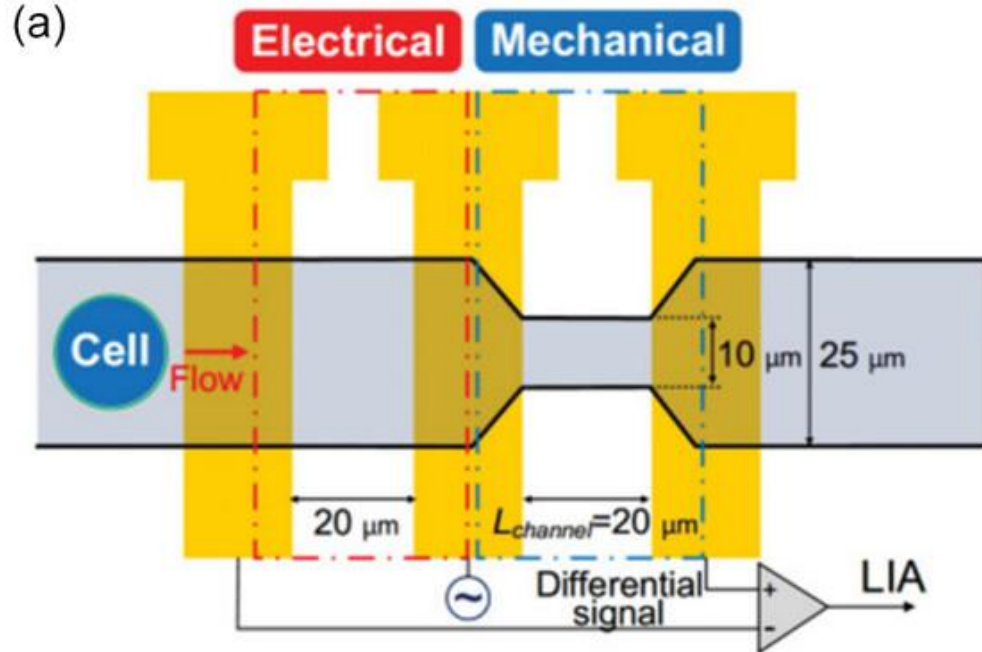

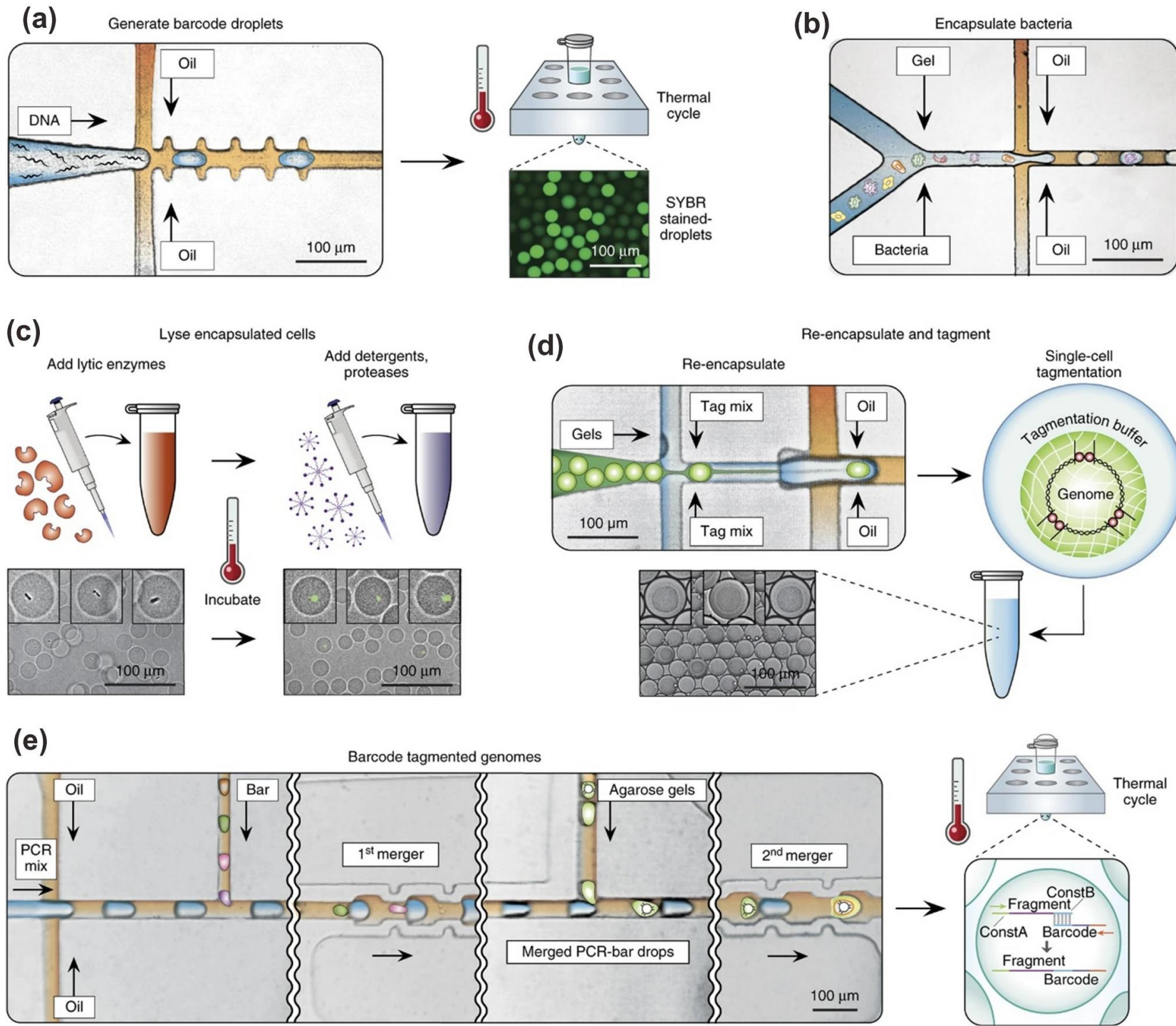



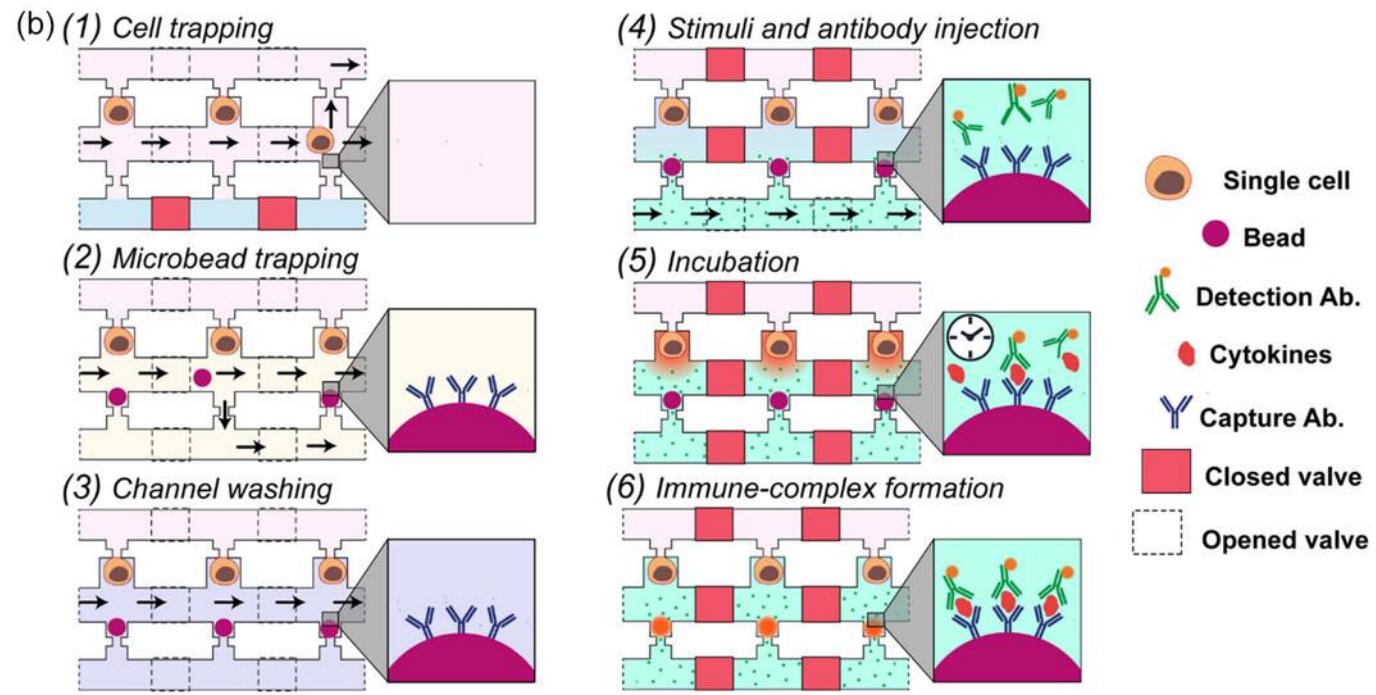
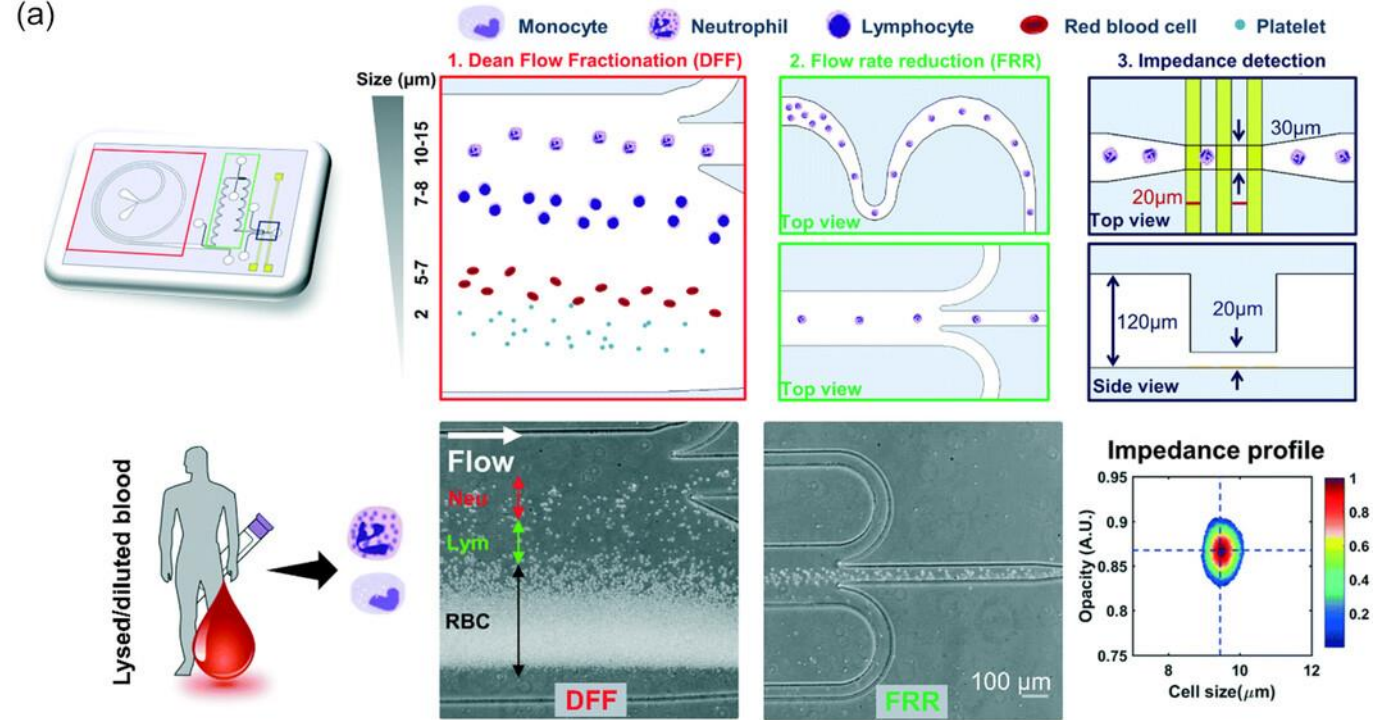

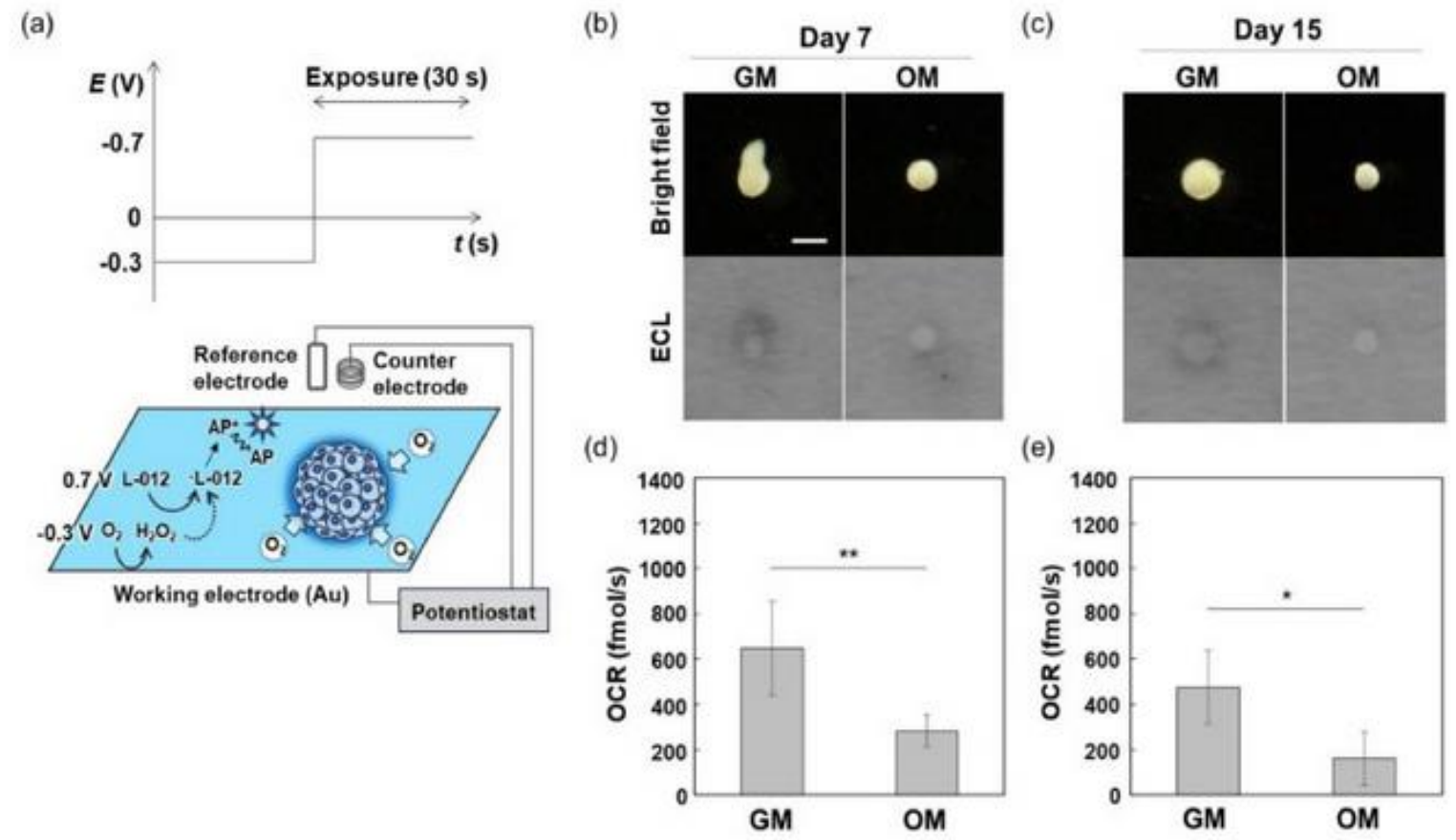
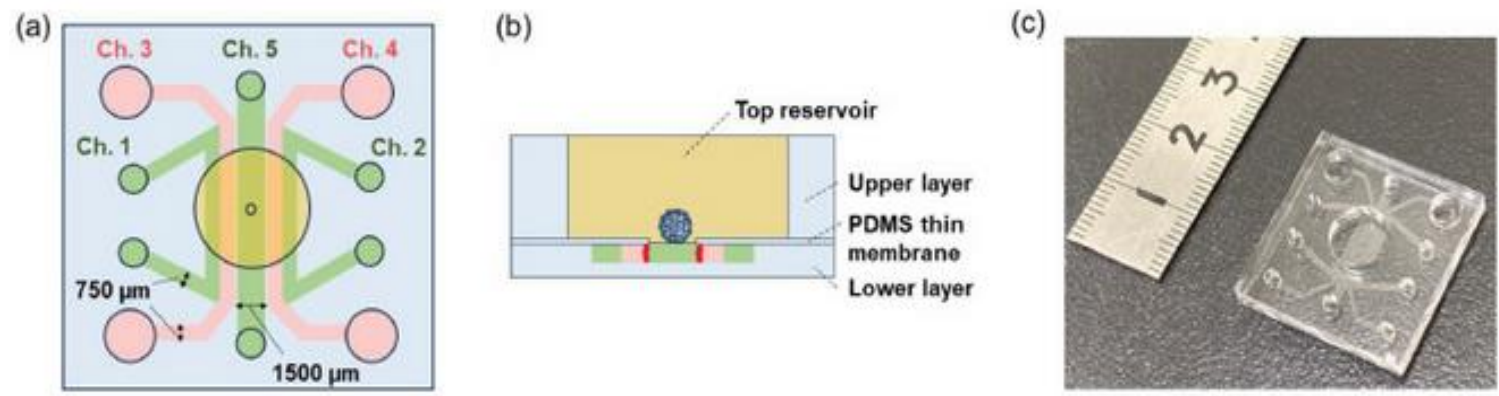

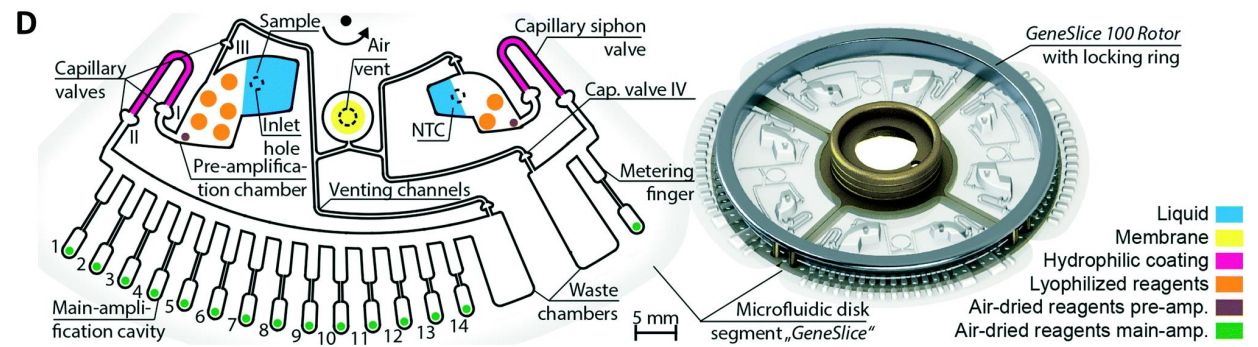
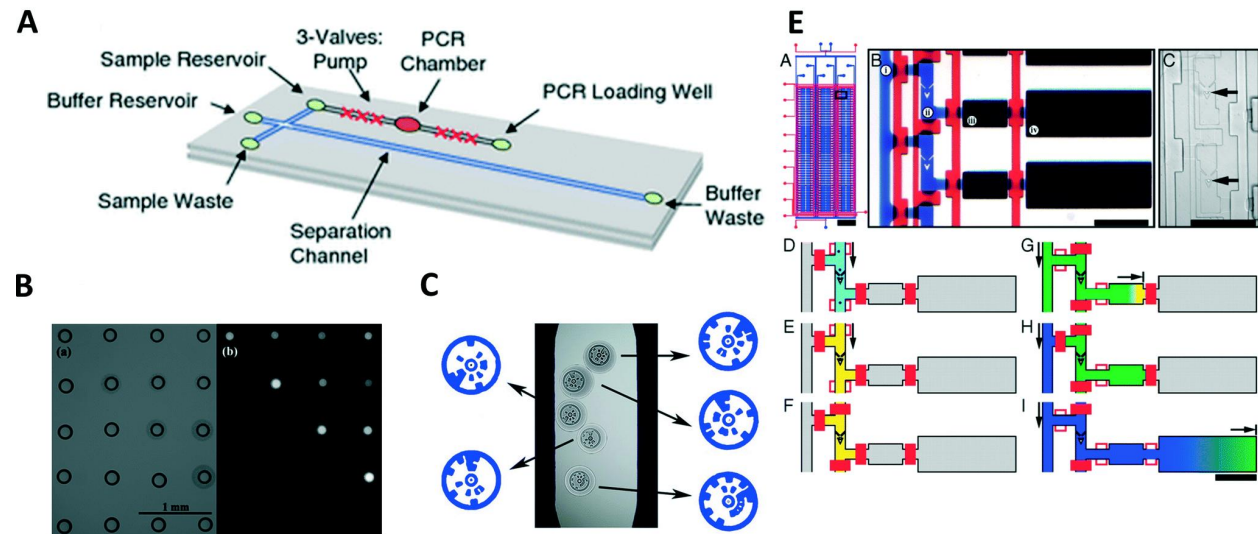
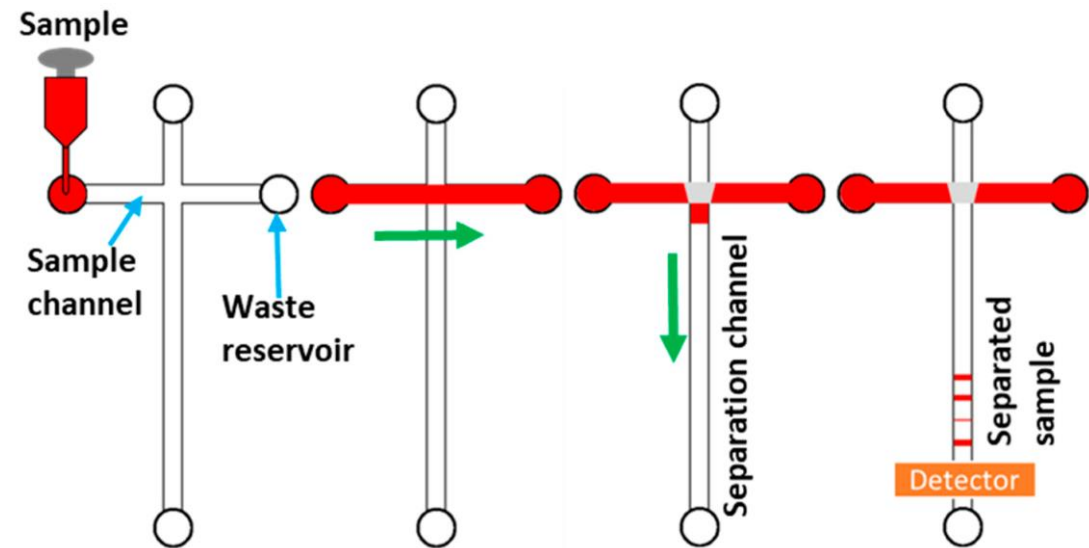
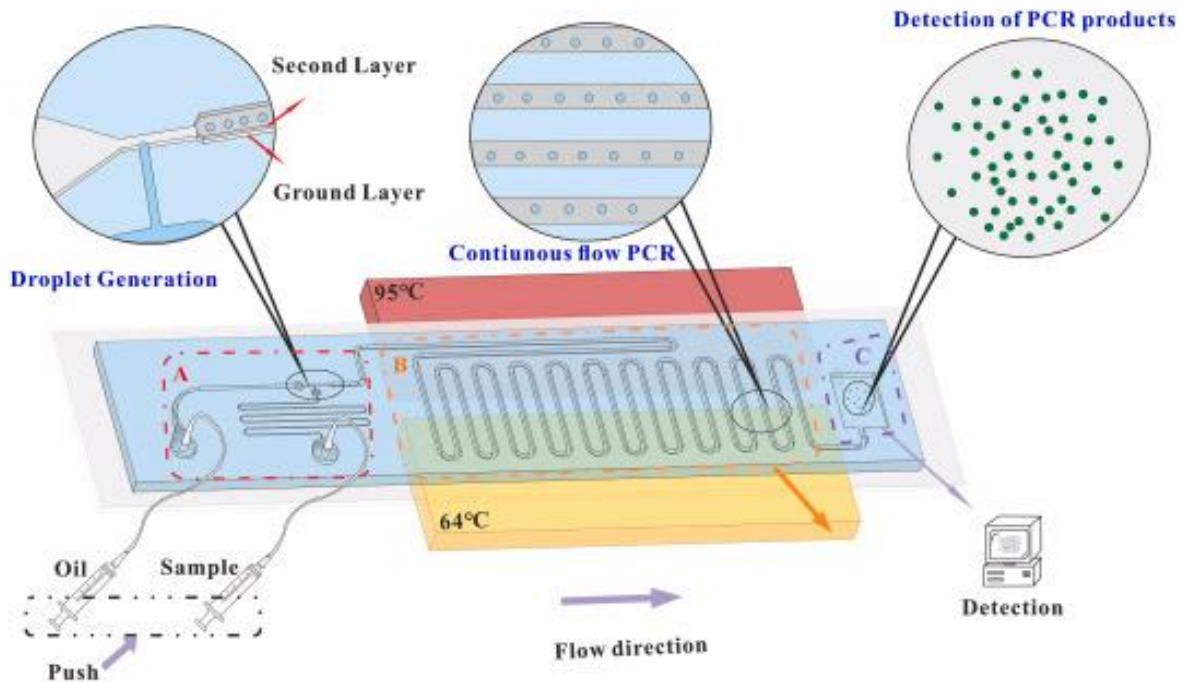

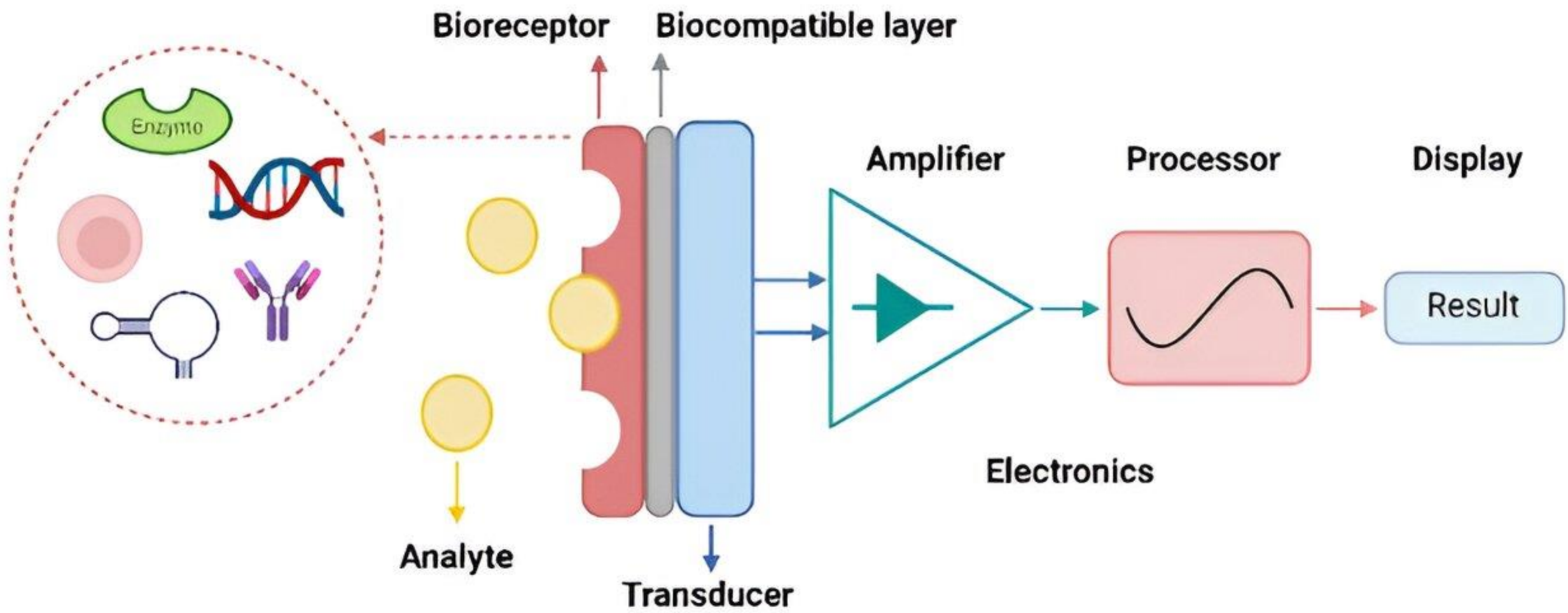

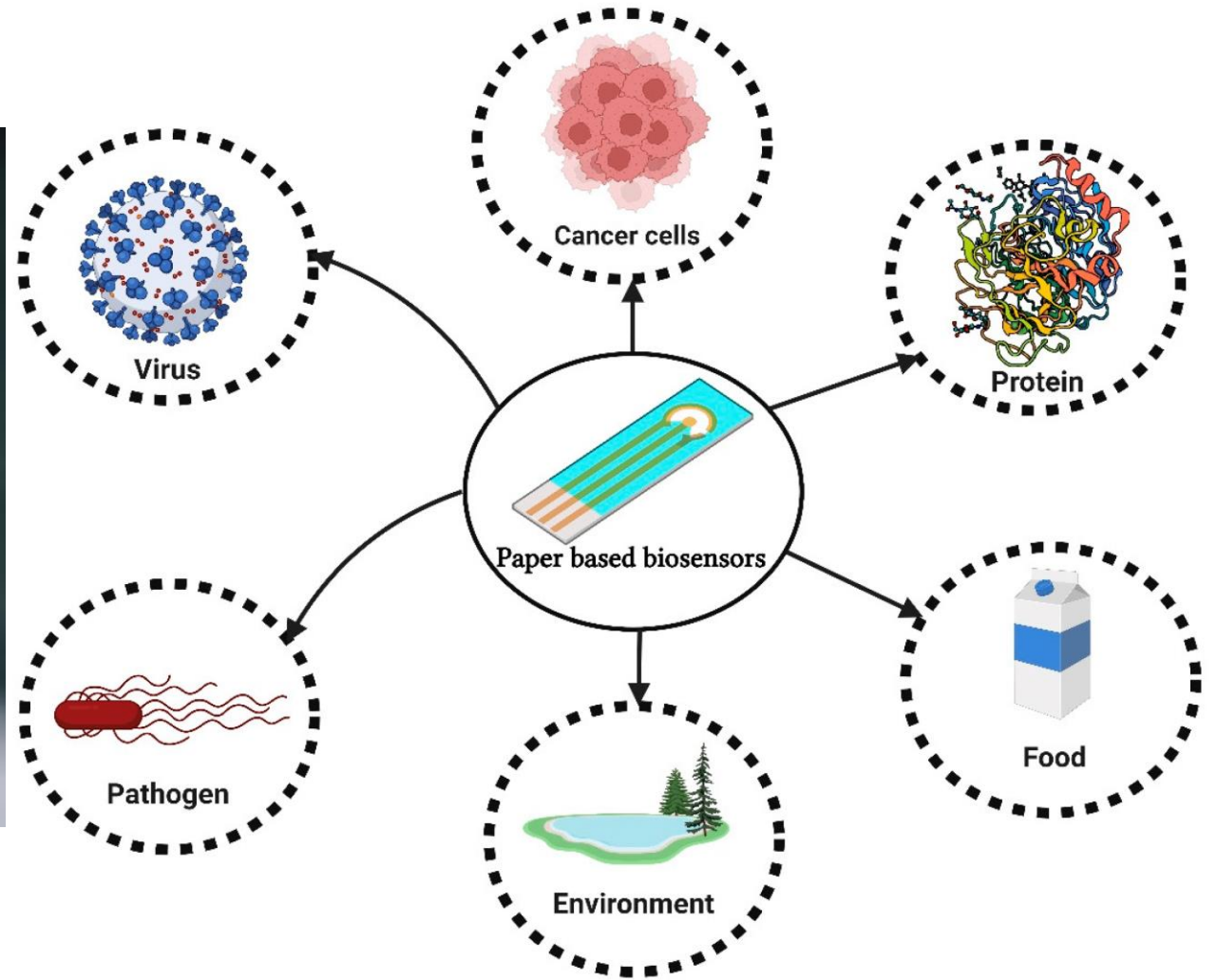
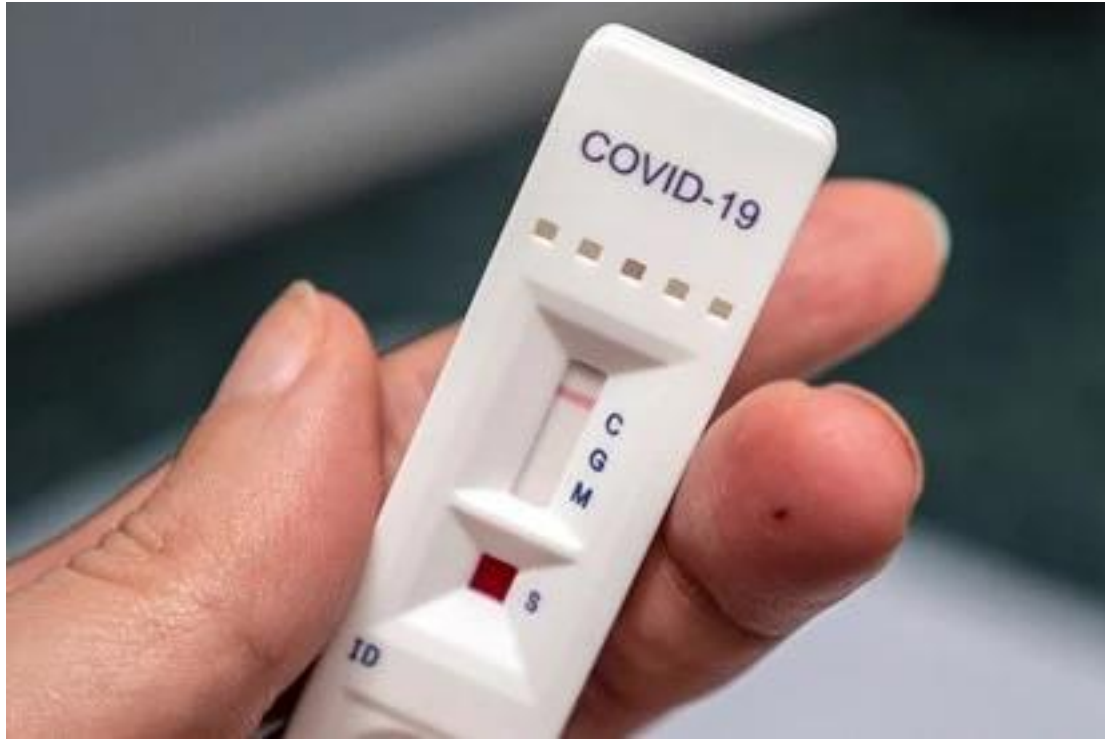

A futuristic, glowing circular interface with the text "THANK YOU FOR YOUR TIME" in the center. The interface is composed of multiple concentric rings of light, with colors ranging from blue and purple to orange and red. The background is dark with scattered light points and a grid pattern. The text is in a bold, sans-serif font, with "THANK YOU" on the top line and "FOR YOUR TIME" on the bottom line.

THANK YOU  
FOR YOUR TIME

